

GSx^{plus} USER'S MANUAL

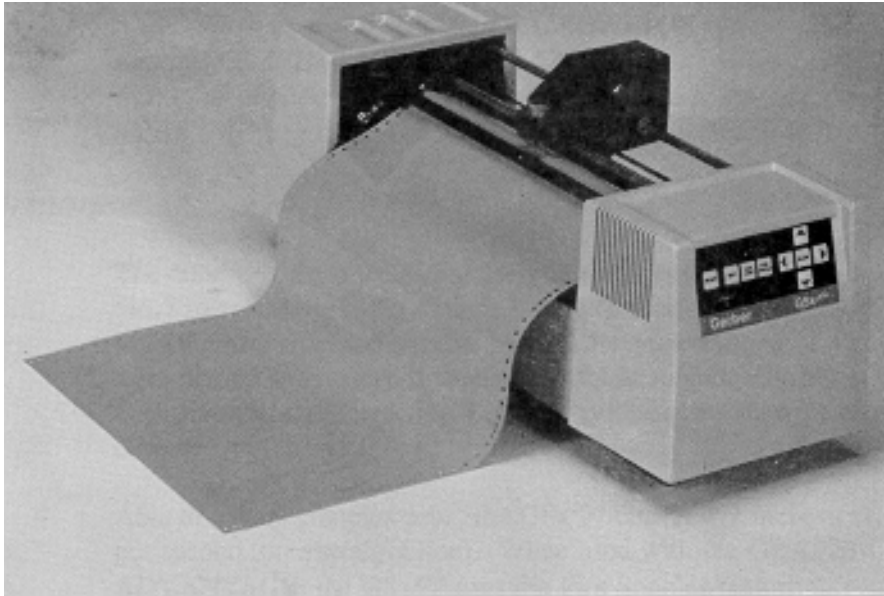

COPYRIGHT NOTICE

COPYRIGHT 2011 Gerber Scientific Products, Inc. All Rights Reserved.

This document may not be reproduced by any means, in whole or in part, without written permission of the copyright owner.

This document is furnished to support the GSx^{plus}. In consideration of the furnishing of the information contained in this document, the party to whom it is given assumes its custody and control and agrees to the following:

1. The information herein contained is given in confidence, and any part thereof shall not be copied or reproduced without written consent of Gerber Scientific Products, Inc.
2. This document or the contents herein under no circumstances shall be used in the manufacture or reproduction of the article shown and the delivery of this document shall not constitute any right or license to do so.

PRINTED IN U.S.A.

GSx^{plus}, Knife Mode Switching, Corner Correcting Technology, IP Plus, Gerber Mask, and GERBER EDGE are trademarks of Gerber Scientific Products, Inc. GerberCal is a registered trademarks of Gerber Scientific Products, Inc. 3-in-1 is a registered trademark of Boyle-Midway, Inc. HP-GL is a registered trademark of Hewlett Packard. ScotchCal and Scotchlite are trademarks of 3M.

FCC NOTICE

This equipment has been tested and found to comply with the limits for a Class A digital device, pursuant to Part 15 of the FCC rules. These limits are designed to provide reasonable protection against harmful interference when the equipment is operated in a commercial environment. This equipment generates, uses, and can radiate radio frequency energy and, if not installed and used in accordance with the instruction manual, may cause harmful interference to radio communications.

Operation of this equipment in a residential area is likely to cause harmful interference in which case the user will be required to correct the interference at his own risk.

This digital apparatus does not exceed the Class B limits for radio noise emissions from digital apparatus set out in the Radio Interference Regulations of the Canadian Department of Communications.

Le present appareil numerique n'emet pas de bruits radioelectriques depassant les limites applicables aux appareils numeriques de la classe B prescrites dans les Reglements sur le brouillage radioelectrique edicte par le Ministere des Communications du Canada.

Table of Contents

Table of Contents.....	3
Chapter 1: Introduction.....	5
Description	5
Performance	5
Convenience	5
Support Information	6
About This Manual	6
Conventions	7
Package Contents.....	7
Chapter 2: Installation.....	8
Plotter Work Area.....	8
Connect to the Plotter.....	9
Communication Parameters	9
Power Cords.....	10
Power-Up Sequence	10
Chapter 3: Set up	11
Plotter Selection	11
Add Plotters	13
Delete Plotters	13
Assign Default Plotter.....	14
Chapter 4: Materials and Tools	15
Materials	15
Tool Force Dial.....	18
Chapter 5: Tools and tool handling.....	20
Storage.....	20
Tool Holders.....	20
Pen Holder and Pens.....	21
Knife Holder and Blades	23
Chapter 6: Operation	26
Power-Up.....	26
Front Panel	26
Chapter 7: Special Diagnostics.....	31
Diagnostic Options.....	31

Chapter 8: Error Conditions	34
Chapter 9: Maintenance	36
Cleaning and Lubrication.....	36
Fuse Replacement.....	38
Chapter 10: Plotter Adjustments	40
Troubleshooting Guide.....	40
Z Axis (Tool Height) Adjustment.....	42
X Axis Belt Adjustment.....	45
Y Axis Backlash Adjustment.....	48
Drum End Play Adjustment	50
GSx ^{plus} Plotter Assembly	53

Chapter 1: Introduction

Description

The GSx^{plus}™ is a state of the art 15-inch (38.1 cm) plotter designed for use with the OMEGA® system and other sign design systems.



Note: When the GSx^{plus} is used with other sign design systems, contact the system manufacturer to obtain a driver for the GSx^{plus}.

Performance

The GSx^{plus} is designed to precisely register graphics up to 50 yards (45.7 meters) long using carbide blades for crisp, sharp cuts. It cuts up to 25% faster than comparable plotters for rapid cutting of all but the most demanding materials such as sandblast stencil. Gerber's exclusive Corner Correcting Technology™ assures sharp, easy-to-weed corners

Able to handle complex jobs, the GSx^{plus} cuts at 4.7 inches (11.9 cm) per second (on a straight line). When used with OMEGA, the GSx^{plus} uses the Plot Spooler feature to receive and plot files while the operator continues to design at the system.

Convenience



The GSx^{plus} has many features that make it easy and convenient to use:

- Accepts any standard Gerber materials in 15-inch wide rolls.
- Draws, cuts and pounces up to 12.75 inches (32.4 cm) high. Using the OMEGA system Panel feature, the GSx^{plus} can cut text or graphics in strips up to 96 feet (29.3 meters) long and 12.75 inches (32.4 cm) wide.
- Adjustable tool force for uniform cutting with the turn of a dial.
- Stepper motor drive for consistent performance and easy maintenance.
- On-board 4K buffer in addition to OMEGA buffers.

- Quick installation.
- Simple to use keypad requires minimum training

Support Information

If you require assistance, please contact your Gerber distributor or contact the Gerber Technical Support:

	phone: 800-828-5406 fax: 860-871-3862
	gpservice@gspinc.com
	www.gspinc.com

About This Manual

This manual explains the installation and operation of the GSx^{plus} plotter. It assumes the operator is familiar with the OMEGA software system. It tells you how to assemble, install, operate, and maintain your GSx^{plus} as follows:

- The "Introduction" provides information about the GSx^{plus} and a list of contents of the shipping crates.
- "Installation" contains instructions for plotter assembly and connection to OMEGA.
- "Set Up" contains instructions for managing plotters.
- "Materials and Tools" gives information about material, loading the vinyl, and use of the tool force dial.
- "Tools and Tool Handling" discusses procedures on using and replacing the pen, knives, and pounce wheel.
- "Operation" provides information about plotter operation and slew key functions.
- "Special Diagnostics" presents examples and instructions for diagnostic tests.
- "Error Conditions" lists common error conditions and corrective procedures.
- "Service and Maintenance" provides cleaning, lubricating, and fuse replacement instructions.
- "Plotter Adjustments" includes a troubleshooting guide as well as symptoms of plotter adjustment problems.

Conventions

The following conventions are used in this manual:



Note: A note contains important information which could affect successful completion of a task.



CAUTION: A caution statement contains information which, if not observed, could result in damage to the equipment.



WARNING: A warning statement contains information which, if not observed, could result in personal injury

Package Contents

This section lists the contents of the GSx^{plus} shipping container. As you unpack the GSx^{plus} plotter, inspect all items for damage that may have occurred during shipping. Report any damage to your dealer at once. Save all packaging materials in case it becomes necessary to transport the plotter at a future date.

The GSx^{plus} package contains the following:

1	GSx ^{plus} plotter assembly	1	User's Manual
1	Roll holder	1	Warranty card
1	Plotter power cord	1	Service contract
1	10 foot RS-232 cable	1	Tool Kit
2	fuses		

Contents of tool kit

1	Pen holder with pen
1	Knife holder with knife
1	Tool lift washers (on tool holders)
2	Spare life washers
1	Allen wrench
1	Pair tweezers
1	Pen height gage

Chapter 2: Installation

Please unpack the plotter boxes and inventory the contents before you begin to assemble the plotter. Follow these instructions to install the GSx^{plus} plotter to any OMEGA. Installation of the GSx^{plus} to other sign design systems is described separately.



Note: Should you experience difficulty during installation of the GSx^{plus} to the OMEGA system, contact Gerber Field Service Department at 800-828-5406.

Plotter Work Area

- 1 Carefully remove the GSx^{plus} from its packaging materials and place it near the OMEGA system. The cable is 10 feet (3.1 meters) long, so the plotter need not be located immediately beside the console; however, it should be close enough so there will be no strain on the cable after installation.
- 2 Place the material roll holder next to the plotter on the right side.

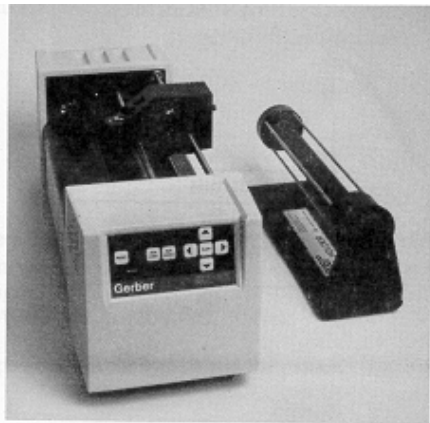

Connect to the Plotter



CAUTION: Be sure power is turned off and the power cord is unplugged at both the OMEGA system and the plotter.

- 1** Insert the 9-pin connector at the end of the RS-232 cable into the 9-pin RS-232 connector on the back of the computer system.
- 2** Carefully align all pins. Use the connector thumb screws to secure the cable to the system.
- 3** Insert the 25-pin connector at the end of the RS-232 cable into the 25-pin RS-232 connector on the back of the plotter.
- 4** Carefully align all pins. Secure the cable to the plotter with the connector thumb screws.

Communication Parameters

If you are connecting the GSx ^{plus} to a system other than the OMEGA, the plotter uses these RS-232 communication parameters:

Communication Parameters
9600 Baud
No Parity
8 Data Bits
1 Stop Bit
Xon/Xoff Flow Control

The plotter has a 25DB female connector with these pin assignments:

Pin	Signal
2	Tx
3	Rx
4	RTS
5	CTS
7	Sig Gnd

All other pins are not connected.

Power Cords

- 1 Insert the female connector of the GSx^{plus} plotter power cord into the socket on the rear panel of the plotter.

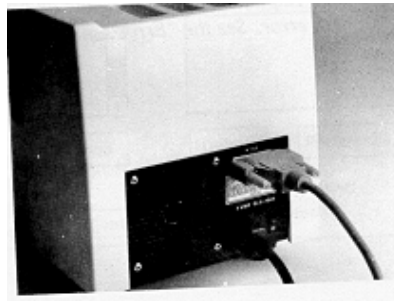

- 2 Connect the power cords for both the OMEGA system and the GSx^{plus} to a multiple outlet strip. The strip should be plugged into a standard, grounded electrical outlet (115V +/- 10% AC, 60 Hz or 230V AC, 50 Hz).
- 3 Turn power on at the system and the plotter.



CAUTION: When the power is on, never try to manually move the carriage, move the drum, rotate the tool, or force the tool up or down. Attempting to manually move the GSx^{plus} in any axis of movement while the power is on may damage the plotter.

Power-Up Sequence

When the GSx^{plus} is turned on, the following sequence occurs:

- 1 A short beep sounds, the Power light comes on, and the RUN CONT and RUN SINGLE lights blink.
- 2 As the GSx^{plus} performs self-check tests, the lights over the RUN keys flash, and one additional beep sounds.
- 3 When the self-check is complete, the lights blink and the plotter beeps.
- 4 The plotter beeps and goes off-line. Only the power light remains on. This is the initial setting at power-up.

Note: Rapid, continuous beeping and flashing lights may signal a self-check error. See the "Error Conditions" section for more information.

Chapter 3: Set up

After connecting the plotter to OMEGA, you will use the GQMgr program in OMEGA to make the GSx15^{plus} accessible. When using the GSx15^{plus} with sign design systems other than OMEGA, contact the system manufacturer to obtain a driver for the GSx15^{plus}, installation instructions, and setup information.

Plotter Selection

1 Open GQMgr.

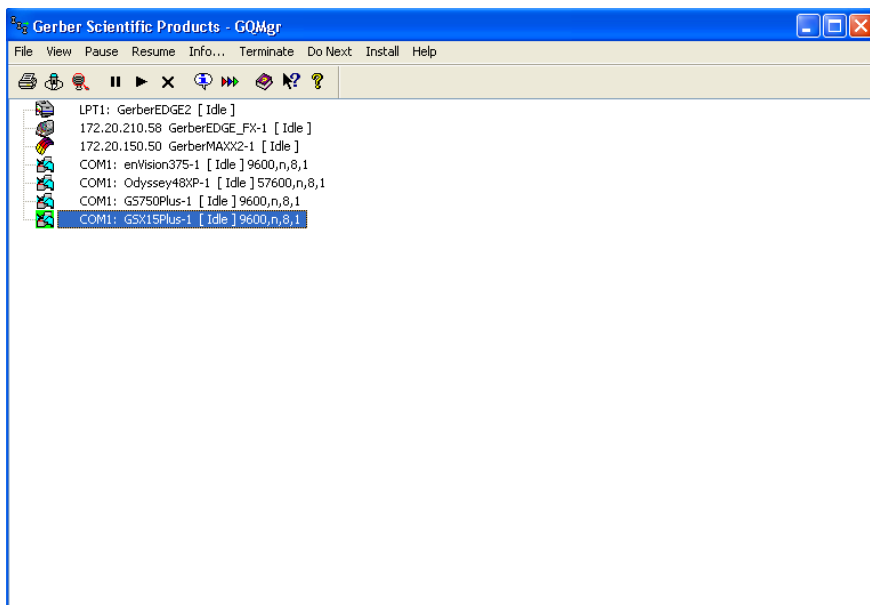

- 2 Click Install, in the drop down menu select plotter. The Add or Delete Plotter/Router(s) dialog box opens.
- 3 Click the GSx15^{plus} in Available Plotter/Router(s) to highlight it.

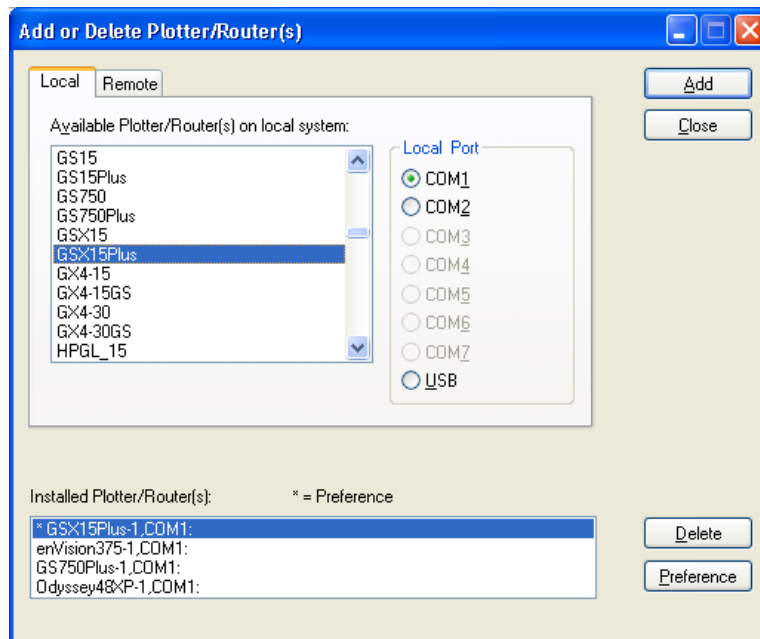

- 4 Click the Com Port to which the plotter is connected Com 1 through 7 in the ports box.
- 5 Click Add. An Add – Name Device dialog box opens. Read the on line instructions then click OK.



- 6 Select GSx15^{plus} in the Installed Plotter/Router(s) box, then click Preference..



Note: The default plotter is noted by an asterick to the left name in the installed plotter list box.

- 7 Click Close. You will return to GQMgr.

- 8 The GSx15^{plus} plotter can now be accessed through OMEGA.

Add Plotters

Multiple plotters can be added to your system. They must be added one by one.

- 1 Click the plotter you wish to add from the plotters list box.
- 2 Click the port it will be connected to.
- 3 Click Add. The highlighted plotter is added to the Installed Plotter/Router(s) dialog box.
- 4 Click Close. You will return to GQMgr.



Note: For each plotter you add, a number is added after the plotter model number (for example, GSx-1 for the first plotter added, GSx-2 for the second).

Delete Plotters

➤ To remove plotters from the system

- 1 Open GQMgr.
- 2 Click Install, in the drop down menu select plotter. The Add or Delete Plotter/Router(s) dialog box opens.
- 3 Select the plotter you want to delete in the Installed Plotter/Router(s) dialog box to highlight it.
- 4 Click Delete. The plotter will be removed from the list.
- 5 Click Close. You will return to GQMgr.

Assign Default Plotter

A default plotter can be assigned if more than one plotter is connected to OMEGA.



*Note: There must be two or more plotter names in the **Ready for Plotting** box to select a default plotter. If only one plotter is installed to the OMEGA system, that plotter will automatically be assigned as the default plotter.*

➔ To assign a default plotter

- 1 Highlight the name of the desired default plotter in the Installed Plotter/Router(s) dialog box.
- 2 Click Preference. An asterick will appear to the left of the plotter name.
- 3 Click Close. You will return to GQMgr.

Chapter 4:

Materials and Tools

Materials

The GSx^{plus} uses the same plotting materials as all Gerber plotters. Gerber vinyl products in high performance or intermediate grades are available in translucent, reflective, or metallic finishes and come in a wide range of colors. Also available are direct-cut screenprint stencil, ruby photo film, paint masking material, rubber sandblast stencil material and heat transfer materials. Consult your Gerber distributor for further information about available materials, colors and prices. Always insist on Gerber authorized materials for highest quality results.

➔ To load material



CAUTION: Gerber recommends that you load material without a tool in the carriage to prevent damaging the knife blade.

- 1 Slide the roll of material to be used onto the roll holder. Pull the end of the material away from and over the top of the roll holder toward the plotter.

CAUTION: When power is on, the carriage spindle must be moved only by using the slew keys. Attempts to manually move the plotter drum, rotate or force the tool up or down will damage the plotter.

CAUTION: While power is off, center the carriage by gently pushing toward the center of its travel. Take care to move the carriage slowly and firmly by gripping the right end of the carriage housing, not by gripping the carriage spindle.

CAUTION: Do not use the way shafts to lift or turn the GSx^{plus}. This will damage the system and reduce plotting accuracy.

- 2 Center the carriage spindle preferably by using the slew keys (see "Front Panel" section) or manually, with certain precautions as outlined here. Be sure that the carriage spindle is not located at either extreme end of its travel and that both ends of the rubber drum can be reached easily.
- 3 Open the bail arms at either end of the drum by pulling them up and away from the drum.
- 4 Using the slew (arrow) keys, rotate the drum until three closely spaced pins are visible. These three sprocket pins are used to align the material.

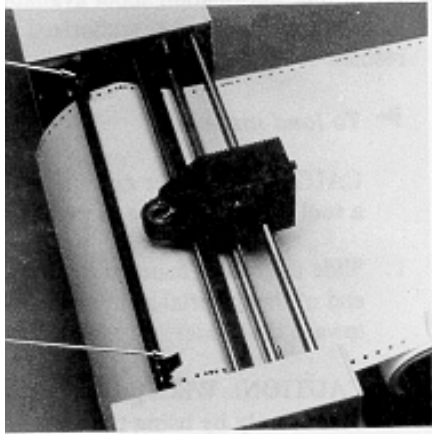

➤ **To feed and align material**

- 1 Feed material under the black cam shaft and over the rubber drum. See the illustration below.

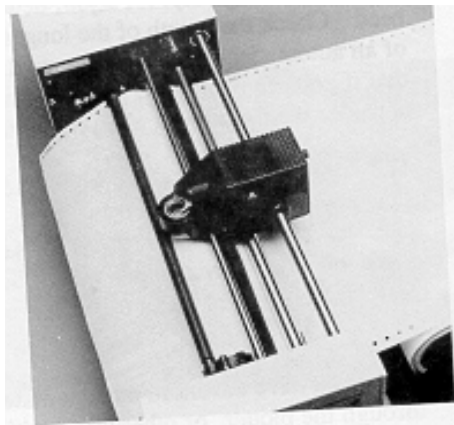

- 2 Place the holes in the material over the sliding sprocket pins first. Match the three closely spaced sprocket pins and holes.

- 3 Slide the material and the sliding sprocket to reach the fixed sprocket and place the material over these sprocket pins.
- 4 Center the bail arms over the sprockets. Move the adjustable bail arm at the rear of the plotter slightly forward or backward to accommodate small differences in the material width. Securely close the front bail arm first and then the rear bail arm.

Helpful hints

- When you change materials, open the bail arms and roll the material back onto the roll. Tape the ends securely to prevent the roll from unraveling.
- Before unrolling vinyl for a job, determine how much material you need. Check the length of the longest line in the job, or the width of an automatically laid out sign or digitized design. Remember that if you are plotting in the Axis Swap mode, you need to consider the height of the job rather than its width.
- The most practical way to unroll material for a job is to use the slew keys on the plotter. It is best to unroll more than enough material, rather than "just enough," in case your estimate is not accurate. You may also pull material from the roll by hand. This may be the simplest method if you are plotting relatively small jobs.
- When you have advanced enough material for the job, feed it back through the plotter, or otherwise position it appropriately according to the tool start position selected from OMEGA. If you have a large quantity of material piling up on the table, be sure to arrange the material in loose accordion folds so it can feed easily. Make sure the material is positioned to feed straight into the plotter rather than at an angle.

Tool Force Dial

The tool force dial on the front of the housing indicates the tool force setting and the amount of tool force, or pressure that is applied to the tool during operation. This pressure ensures uniform cuts and pen lines. Tool force can be adjusted by turning the small knob on the end of the tool force housing, as shown in the illustration below.

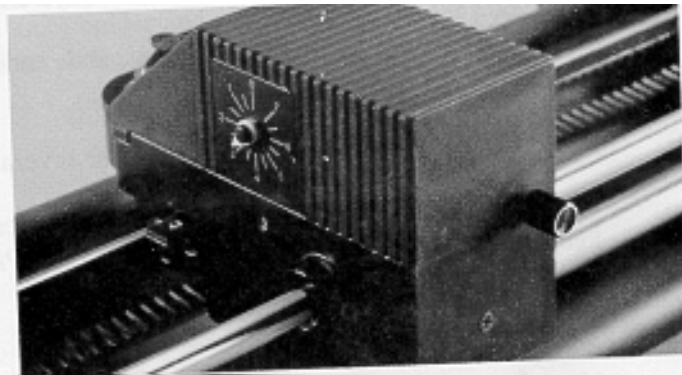

Settings

The *Plotter User Reference Card* at the end of this manual lists approximate tool force settings. Be sure to refer to this list of settings when changing materials or applications. Below are some initial suggestions.

- For drawing, start with a tool force setting of about .5. If your pen does not make a clear dark line, you may wish to increase the tool force setting.
- When cutting regular vinyl, set the tool force setting at 1. The knife will not pivot at corners and will begin to cut through the material if the pressure is set too high.
- Heavier material, such as reflective vinyl, requires increased tool force settings.
- Worn blades require increased tool force settings.
- Before cutting, refer to the *Plotter User Reference Card* at the back of this manual for suggested tool force settings for different tools and materials. Set the tool force accordingly. If you find that different tool force settings produce more satisfactory results with your particular system, tools, and materials, be sure to mark the preferred settings on your card for future use.

Adjustments

Several factors affect tool force and require setting changes:

- Type of material — See Plotter User Reference Card.
- Knife and tool — Drawing, cutting, and blade angle all affect the tool force setting
- Blade wear — Increase tool force after several thousand cuts.
- Gerber recommends experimenting with tool force settings as well as keeping a logbook of the settings. Refer to the *Plotter User Reference Card* for guidelines.

Chapter 5: Tools and tool handling

Storage

A tool rack is molded into the rear cover of the GSx^{plus}. The pen holder, knife holder and pounce wheel holder may be removed from the tool kit and stored here for easy access.

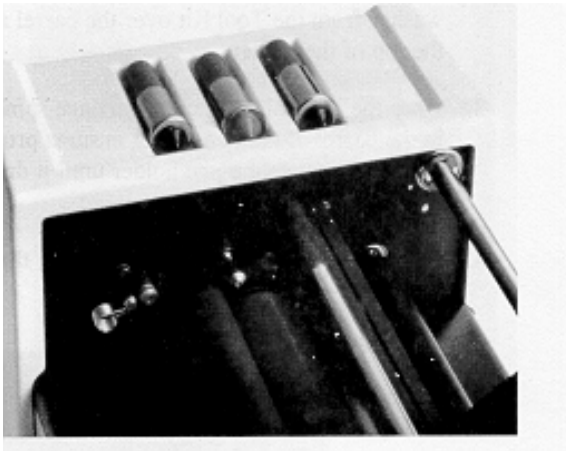

Tool Holders

For quick identification, each tool holder has a different colored cap. The cap helps lock the tool in place in the carriage spindle during operation. In addition, red sleeves protect tool tips from accidental damage during storage. Remove the protective sleeve before installing a tool holder in the carriage spindle.

Pen Holder and Pens

The pen holder is shipped with a black pen installed. After loading the plotting paper, install the pen holder in the carriage spindle as follows:

➔ To install the pen holder

- 1 Select the pen holder with pen installed from the tool rack molded in the rear cover.
- 2 A plastic lift washer is used to reduce friction between the tool holder and the lift fork of the carriage spindle during operation. There should be one installed on the pen holder. If not, slip a lift washer from the Tool Kit over the barrel and slide the washer to the top of the holder.
- 3 Drop the pen holder into the carriage spindle. A slot, or keyway, in the barrel of the pen holder ensures proper orientation. If necessary, rotate the pen holder until it drops completely into the carriage spindle.
- 4 When the pen holder is in place, swing the tool force arm and snap it over the cone-shaped cap.



- 5 For plotting, start with a tool force setting of about 5. (See *Plotter User Reference Card*.) If the pen does not make a clear, dark line, increase the tool force setting.

Pen Replacement

Spare pens in blue and red are included in the tool kit. Additional pens are available through a Gerber distributor.

➔ To replace a pen

- 1 Insert a flat-tip screwdriver into the notch at the base of the cone-shaped cap (see below). Pry out the cap.

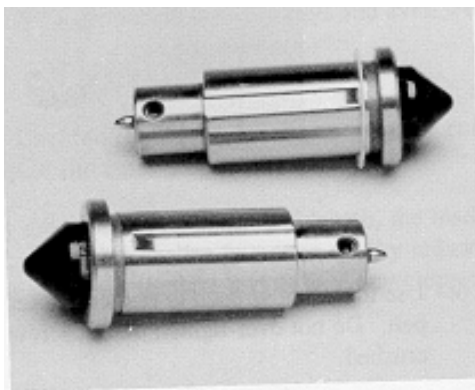

- 2 Use the Allen wrench supplied with the tool kit to loosen the hex screw located near the tip of the pen. Remove the pen through the top of the holder.
- 3 Insert a new pen, tip first, into the top of the holder.
- 4 The pen height gage included with the tool kit is a washer 1/8" thick. Place the pen height gage on a smooth, hard surface like a table top. Position the lower end of the pen holder on the gage.
- 5 Push down on the upper end of the pen until the point just touches the table surface.

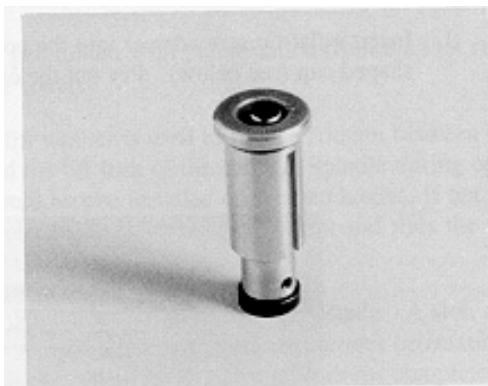

- 6 Use the Allen wrench to tighten the set screw near the tip of the pen. Do not over-tighten the set screw or the pen could be crushed.
- 7 Replace the cap in the barrel.

Knife Holder and Blades

Gerber blades are extremely wear-resistant. In testing, over 10,000 one-inch letters were cut using a single blade before testing was discontinued with the blade still cutting satisfactorily. Other blade manufacturers have attempted, unsuccessfully, to duplicate this cutting precision and durability. Gerber warrants cutting quality of the GSx^{plus} only when Gerber blades are used.

Blade Wear

The knife blade will dull slightly after cutting thousands of characters. Blade wear is always a gradual change. Adjusting tool force will extend blade life for a period of many days and even weeks of use.

Blade Damage



CAUTION: Carbide blades are brittle and can be ruined by the slightest chip of the cutting tip.

Because they are ground to a controlled length, the blades cannot be re-sharpened. A sudden decline in cutting quality indicates that the knife blade is chipped. Replace and discard any chipped blade.

Knife Holder Installation

Follow these instructions to install the knife holder.

➔ To install a knife holder

- 1 Load vinyl or other material.
- 2 Select the knife holder that matches the knife mode you want to use.
- 3 A plastic lift washer is used to reduce friction between the tool holder and the lift fork of the carriage spindle during operation. There should be one installed on the knife holder. If not, slip a lift washer from the Tool Kit over the barrel and slide the washer to the top of the holder.



CAUTION: Carefully install the knife holder, taking care not to strike the tip of the blade against the bore of the carriage spindle.

- 4 A slot or keyway in the barrel of the knife holder ensures proper orientation. If necessary, rotate the knife holder until it drops completely into the carriage spindle.
- 5 When the knife holder is in place, swing the tool force arm and snap it into place over the cone-shaped cap.
- 6 Select a tool force setting appropriate for material and blade. Approximate tool force settings for cutting other vinyl materials are listed in the chart below. (See *Plotter User Reference Card*.)

Suggested Tool Force Settings

Material	Recommended Starting Tool Force	GS Plotter Swivel Knife
Controltac 180 Delux 210 Gold/Silver Dusted Crystal 210 Florescent 210 Scotchcal 220 Translucent 230	.05-1	35°
Gerber Cal Gerber IP Plus Gerber Mask I & II Heat Transfer Flock Hot Split Plastisol Metalized Polyester	1	35°
Screen Print Static Cling	.05	35°
Sandblast 521 Sandblast 522	Not recommended for use with GSx ^{plus}	

To determine if adjustment of the tool force setting is required, consider that:

- ◆ The weed should peel off easily.
- ◆ There should be no cuts through the backing material.

Use the minimum tool force setting that cuts satisfactorily. Too much force will reduce edge quality.

Blade Replacement

One carbide knife blade is included with the GSx^{plus}.



WARNING: The blade is very sharp. Take care when handling the knife holder and blade.



CAUTION: Blades are fragile and can break. Do not use tools to handle new blades.

➔ To replace and adjust the swivel knife blade

- 1 Remove the plastic adjustment shoe from the base of the tool holder by rotating it counter-clockwise until it comes completely off the tool holder. Leave the rubber O ring in place.
- 2 With the shoe removed, carefully remove the old blade by grasping it with needle nose pliers and pulling gently.
- 3 Install a new blade in the hole provided, pushing the blade in gently until completely seated.
- 4 Carefully thread the shoe onto the knife holder, turning it clockwise until it is fully seated. This will fully expose the knife blade.
- 5 Rotate the shoe counter-clockwise until approximately .005 inches (about the thickness of two sheets of paper) of the knife showing.

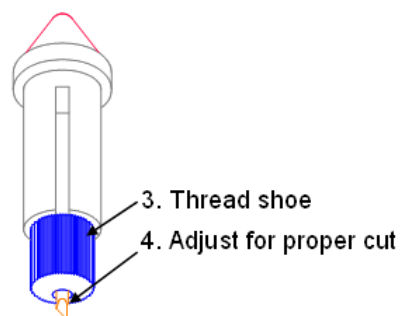
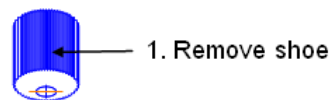
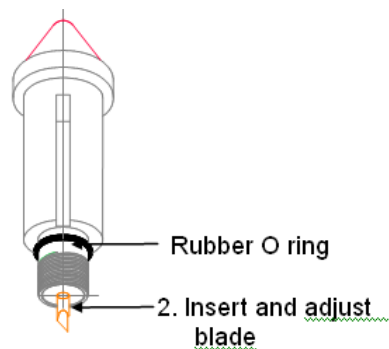

Chapter 6: Operation

Power-Up

When- the GSx^{plus} is turned on, the following sequence occurs.

- 1 A short beep sounds, the Power light comes on, and the RUN CONT and RUN SINGLE lights blink.
- 2 As the GSx^{plus} performs self-check tests, the lights over the RUN keys flash, and one additional beep sounds.
- 3 When the self-check is complete, the lights blink and one beep sounds.
- 4 The plotter beeps and goes off-line. Only the Power light remains on. This is the initial setting at power-up.



Note: Rapid, continuous beeping and flashing lights may signal a self-check error. See the "Error Conditions" section for more information.

Front Panel

The GSx^{plus} front panel keys shown below are used to perform all of the following operations:

- ◆ Position the carriage and material.
- ◆ Put the plotter on-line for drawing, cutting, and pouncing.
- ◆ Select single or continuous job processing.
- ◆ Initialize the knife tool.
- ◆ Access diagnostic modes, as needed. See the *Special Diagnostics* and *Error Conditions* sections for more information.
- ◆ A further explanation of key functions and several test exercises follow.

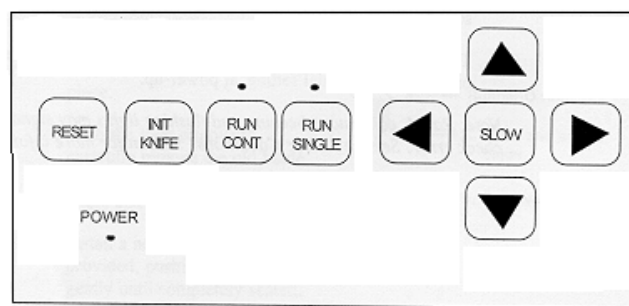

Slew Keys

Use the left and right slew keys to unroll material before plotting, to position the tool for plotting, and to position the carriage and material between jobs.

- ◆ Press the up or down slew keys to move the carriage between the rear and the front of the plotter.
- ◆ Press the left or right slew keys to rotate the drum and feed material through the plotter or back toward the roll holder.



Slow key

Use the SLOW key to access slow slew mode. Slow slew mode moves the platen or tool one step at a time, which simplifies precise registration of artwork produced by the GERBER EDGE™. In normal or slow mode, the platen or tool moves continuously as long as the arrow keys are pressed.



➔ To use the slow slew feature

- 1 Press the SLOW key to select slow slew mode. You will hear a single beep indicating the plotter is in slow slew mode. When you press an arrow key, the platen or tool will move a single step at a time. When you press an arrow key, the drum or carriage will move at a very slow speed as long as you hold the key down.
- 2 Press the SLOW key again to return to normal mode. You will hear two beeps indicating the plotter is in normal slew mode. When you press an arrow key, the platen or tool will move continuously as long as you hold the key down.



Note: The arrow and SLOW keys do not function during the following conditions:

- *while a job is plotting*
- *during an error condition*
- *if a RUN light is on, even if the plotter is idle.*

init knife

Use the INIT KNIFE key to initialize the knife so that the blade faces 0°. Press the INIT KNIFE key after loading the knife.



CAUTION: Pressing INIT KNIFE lowers the knife into the vinyl and cuts very short line. It is important to have material loaded in the plotter so that the knife does not cut the drum surface.



Note: You should initialize the knife before every job if you have changed material, or after a new tool has been installed.

run single

Use RUN SINGLE to plot a single job. This plot mode allows the operator to reposition material between jobs and/or to pen plot using paper before cutting vinyl



Plot

- 1 Press RUN SINGLE. The light over the RUN SINGLE key comes on and the GSx^{plus} plots a single job. If other plot files are received from the OMEGA while the first job plots, then a waiting list, or *queue*, of these jobs is created.

The GSx^{plus} returns to the off-line status after the job plots.

The GSx^{plus} waits for the operator to press the RUN SINGLE key again to plot the next job. If other jobs are lined up in the queue, the green lights above the two RUN keys will flash.

Controlled Stop

Use RUN SINGLE (or RUN CONT) to pause plotting.

- 1 Press the currently selected RUN key during a job to pause the job. The GSx^{plus} stops the job at the next logical break in the program.



Note: Do not use slew keys or orientation for the current job will be lost.

- 2 Press either RUN key to resume plotting at the exact same point.

Single Plot Exercise

- 1 Turn on the GSx^{plus}. Load plotting paper, test the pen manually, install the pen holder, and set the tool force to .5.

- 2 Using the slew keys, position the carriage spindle approximately 1" from the front edge of the plotting paper. Also, be sure that there are several inches of paper extending past the carriage spindle and to the left of the plotter.
- 3 Send a plot file to the GSx^{plus} plotter.
- 4 Press the RUN SINGLE key to plot the test exercise.

run cont

Use RUN CONT to access the continuous plotting mode and maximize the plotter's productivity.



**RUN
CONT**

➔ To plot in continuous mode

- 1 Press RUN CONT. The light above the RUN CONT key comes on and the GSx^{plus} plots one job after the other without waiting for user prompting between the jobs.

The GSx^{plus} creates a waiting list, or queue, of jobs to be plotted. When one job finishes plotting, the next job waiting in the queue begins immediately.

When all jobs in the queue are plotted, the GSx^{plus} remains on-line until the operator presses either RUN key or the RESET key to return to off-line status.

Controlled Stop

Use RUN CONT (or RUN SINGLE) to pause plotting and check the current job.

➔ To stop a continuous mode plot

- 1 Press either RUN key. The GSx^{plus} stops the plot at the next logical break in the program. **Do not use slew keys or orientation for the current job will be lost.**
- 2 Press either RUN key to resume plotting at the exact same point.

Continuous Plot Exercise

- 1 Turn on the GSx^{plus}. Load plotting paper, install the pen holder, and set the tool force to .5.
- 2 Using the slew keys, position the carriage spindle approximately 1" from the front edge of the plotting paper. Be sure that there are several inches of paper extending past the carriage spindle and to the left of the plotter.

- 3 Prepare two plot files. If using OMEGA to prepare the files, in the Plot Program choose a left Start Position and a right End Position for both plots before sending them to the plotter. This will prevent the files from plotting on top of each other. If using another layout program, be sure to position the files so they will not plot on top of each other.



Note: Entering an X,Y pre-position in the Plot Program is another way to be sure that plots done in the RUN CONT mode will not plot on top of each other. (See OMEGA Reference.)

- 4 Press the RUN CONT key. Both jobs will plot without a pause between them.

reset

Use the RESET key to stop plotter operation in case of emergency, to clear error signals, and to access Special Diagnostics.



RESET

➤ To cause an emergency stop

Press the RESET key while a job is plotting. The following sequence occurs:

- 1 GSx^{plus} operation stops immediately.
- 2 The current job is cleared. All other jobs in the queue remain intact.
- 3 The GSx^{plus} returns to off-line status, as at power-up.

➤ To clear an error signal

Press the RESET key to clear an error signal (steady tone and flashing lights) after a power-up or plotting failure. (See the "Error Conditions" section.)

➤ To access diagnostics

Hold the RESET key at power-up to access additional diagnostics. (See the "Special Diagnostics" section.)

Chapter 7: Special Diagnostics

In addition to the self-check tests that are part of the power-up sequence, the GSx^{plus} plotter can perform other special diagnostics. The steps to access these diagnostics and their functions are outlined below.

➔ To access special diagnostics

- 1 Hold down the RESET key during power-up.
- 2 When a steady tone sounds, release the RESET key. There will be two beeps followed by three beeps as the self-check tests are completed. Then the lights above the RUN CONT and RUN SINGLE keys will alternate. These alternating lights mean that RESET was held at power-up and that a special diagnostic can now be performed.
- 3 Access one of the special diagnostics described next by pressing the slew key noted in the description.



Note: Only one special diagnostic can be accessed at each power-up sequence. To access another diagnostic, turn the plotter power off and then on again (as described above).

Diagnostic Options

The following diagnostics are available:

- ◆ **RS-232 Loop Back** – Press the up arrow key to access. Used to check internal workings of the communications hardware. Beeps indicate a communications error. (A special loop-back test connector is needed for this test. See your Gerber distributor.)
- ◆ **Wagon Wheel Test Plot** – Press the left arrow key to access. Used to check X, Y, Z axes in plot mode and to verify operation after adjustments are made.
- ◆ **Square/Circle Test Plot** – Press the SLOW key. Used to check X, Y, Z, theta axes in cut mode and to verify operation after adjustments are made.

- ◆ **X08 Cut Test** - Press the down arrow key to access. Used to test cut quality.



Note: If the plotter consistently fails a special diagnostic, contact Gerber Field Service Department at 800-828-5406 or fax at 860-871-3862.

Wagon Wheel Test Plot

➤ To plot the Wagon Wheel test plot

- 1** To access the Wagon Wheel test plot, hold the RESET key while powering up.
- 2** Load plotting paper and install the pen holder.
- 3** Press left arrow key to access diagnostic.
- 4** Press RUN SINGLE to plot once or RUN CONT to plot continuously.
- 5** Compare the test plot to the illustration below. If the plot is different, contact Gerber Field Service.

Square/Circle Test Plot

➤ To plot the Square/Circle test plot

- 1** To access the Square/Circle test plot, hold the RESET key while powering up.
- 2** Load vinyl and install the knife holder.
- 3** Press SLOW key to access diagnostic.
- 4** Press RUN SINGLE to plot once or RUN CONT to plot continuously.
- 5** Compare the test plot to the illustration below. If the plot is different, contact Gerber Field Service.

X08 Cut test

➔ To plot the X08 Cut test

- 1 To access the X08 test plot, hold the RESET key while powering up.
- 2 Load vinyl and install the knife holder.
- 3 Press the down arrow to access diagnostic.
- 4 Press RUN SINGLE to plot once or RUN CONT to plot continuously.
- 5 Compare the test plot to the illustration below. If the plot is different, contact Gerber Field Service.

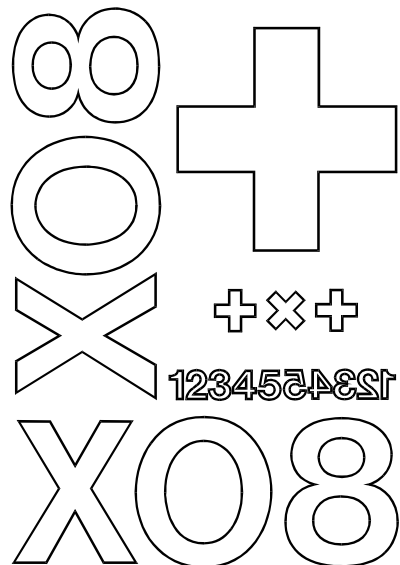

Chapter 8: Error Conditions

The GSx^{plus} is programmed to detect several mechanical/electrical error conditions at power-up or during operation. When an error condition occurs, the plotter will turn off power to the stepper motors, flash the RUN lights, and sound a steady tone.

➔ To determine the error condition that stopped plotter operation

- 1 Press the RESET key to clear the error signal (flashing lights and steady tone).
- 2 Press the RUN SINGLE key to display the error code number. The RUN lights flash the same number of times as the error number (once for Error 1, twice for Error 2, etc.). A short beep indicates the end of the error message. Press the RUN SINGLE key again to repeat the message, if desired.
- 3 Press the RESET key to clear the error display mode and return to the initial off-line status.

Error Codes

The error code numbers and suggested operator responses are listed below. Error code numbers are also listed on the User Reference Card.

Error Number	Description	Operator Response
1	Program checksum failure	Try power-up again.
2	RAM memory failure	Try power-up again.
3	RS-232 test failure	Try power-up again.
4	Illegal plot data command	Check plot data; resubmit job.
5	Corrupt data	Check plot data; resubmit job.
6	Buffer overflow	Contact Gerber Field Service.
7	UART error	Only occurs as part of self-test; try power-up again.
8	*Z axes lock time-out	Power up again, holding RESET key
9	Z axis error	Turn off system; check connectors.
10	Theta home failure	Turn off system; check connectors

*Error code occurs in Special Diagnostic mode, if axes remain locked more than 30 minutes.

If the plotter consistently fails the self-check tests, contact Gerber Field Service Department at 800-828-5406, or fax at 860-871-3862

Chapter 9: Maintenance

This section includes instructions for routine cleaning and lubrication, fuse replacement, and adjustments to keep the GSx^{plus} plotter in good working order.

Cleaning and Lubrication

Routine cleaning and lubrication should be done monthly or after every 160 hours of use, whichever occurs first. Isopropyl alcohol should be used to clean dirty parts.



Note: When alcohol is used, lubricate the parts immediately to prevent corrosion.

Use light oil such as 3-in-1[®] Oil for all lubrication, except as noted.

Tool Holders AND Carriage Spindle BORE



Note: The spindle bore should be cleaned daily.



CAUTION: Do not use oil to lubricate tool holders or spindle bore.

There is a very close fit between the pen, knife and pounce wheel holders and the carriage spindle bore. Any dirt or build-up in the bore or on the tool holder restricts motion and can produce inconsistent results.

- 1 Once a day clean the spindle bore and tool holders with isopropyl alcohol using a clean, dry, lint-free cloth on the tool holders and a clean, dry cotton swab in the bore.
- 2 Wipe the tool spindle with a soft, lint-free, dry cloth. Dust, hair, silicon, and other debris can greatly affect tool performance and letter quality.

Carriage and Ball Bushing

- 1 Use a lint-free cloth and alcohol to clean any dust or debris from the front way, drive shaft, cam shaft and rear way. Rotate the cam shaft and move the carriage assembly for access to the entire length of these shafts.

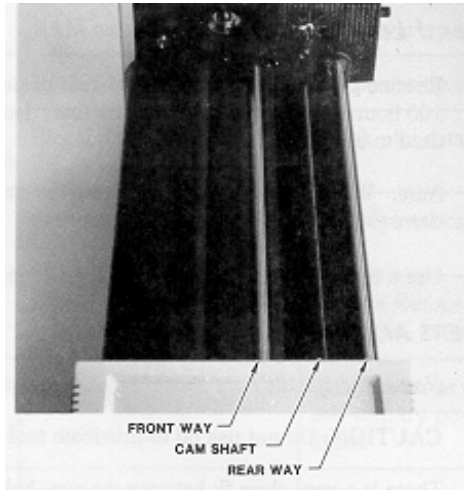

- 2 The rear way and front way should be given a light coat of oil. This is best done by applying with a lint-free cloth.

Sprockets AND Bail Arms

- 1 Inspect the teeth of the drum sprockets for adhesive buildup from the use of vinyl films.
- 2 Use a small stiff brush (such as a toothbrush) dipped in alcohol to clean the sprockets.

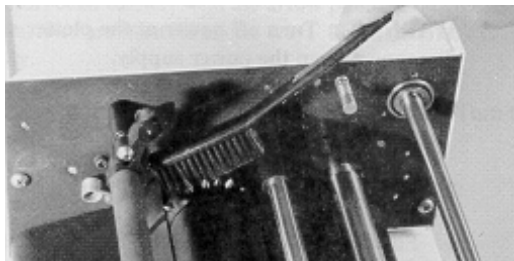

- 3 After using alcohol to clean them, immediately dry the sprockets and drum with a lint-free cloth.
- 4 Place one drop of oil in each pin of the sliding sprocket at the front of the plotter.

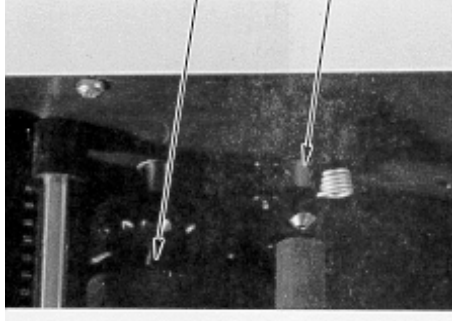

- 5 Slide the sprocket back and forth to work the oil into the bushing.
- 6 Oil the bail arm pins. **Do not oil excessively.**

Fuse Replacement

Two spare fuses are included with the GSx^{plus} Plotter. The fuse holder is located between the on/off switch and the power cord connector on the rear panel of the plotter.

➔ To replace the fuse



WARNING: Turn off power at the plotter and the system and disconnect from the power supply.

- 1 Unscrew and remove the RS-232 cable from the rear panel of the GSx^{plus}.
- 2 Remove the plotter power cord from the socket.
- 3 Find the small notch at the right edge of the black plastic plate on the rear panel.

- 4 Insert a flat-tip screwdriver into the notch and flip the black plastic plate open.

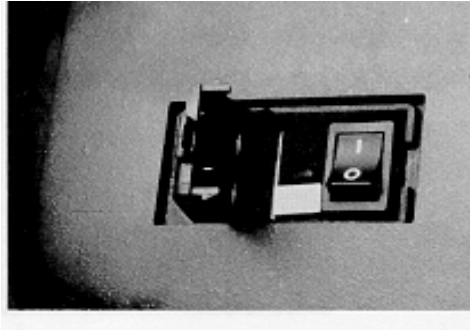

- 5 Pull out the light gray fuse carriers one at a time. Note that each carrier has a white arrow on it and that the arrow points downward (as do the two arrows on the black plastic plate).
- 6 Examine each fuse. Remove any blown fuse. Install a new fuse of the same type and rating in the same place.
- 7 Reinsert each carrier, with the arrow pointing downward. Be sure the carriers are inserted all the way. Close the black plastic plate firmly.
- 8 Reinstall the power cord and the cable connector. Turn the power on at the system and at the plotter.

Chapter 10: Plotter Adjustments

This section contains a troubleshooting guide to help identify possible error conditions according to the symptoms displayed and the recommended adjustment procedures.

It also contains a brief description of plotter adjustment problems that should be handled by contacting Gerber Field Service Department at 800-828-5406.



Note: Gerber warranties do not cover unauthorized repair. Some service procedures require delicate adjustment of plotter parts. If damage to your GSx^{plus} plotter results from improper unauthorized service, repair will NOT be covered by any Gerber warranty.

Troubleshooting Guide

This chart of symptoms is designed to help identify the possible problem and the probable adjustment procedure.



CAUTION: Turn off GSx^{plus} plotter and OMEGA or other sign design system before checking connections or attempting to make any adjustments, unless otherwise directed.

Symptom	Recommended Procedure
No power	<ol style="list-style-type: none"> 1. Check power cable and plugs. 2. Check on/off switches. 3. Check fuse.
Poor Performance	Perform routine cleaning and lubrication.
Plotter Error	Press Reset on the plotter. Verify and resend the job.
Inconsistent Tool/ Material Contact	<ol style="list-style-type: none"> 1. Clean spindle bore and tool holder. 2. Change knife blade. 3. Check for proper Z home. 4. Perform Z Axis Adjustment for Tool Height.

Symptom	Recommended Procedure
Jagged or Serrated Cutting Edges	Replace the knife blade.
Closure Problem	Check in this order: <ol style="list-style-type: none">1. Material alignment in sprockets2. Blade position in knife holder. If the condition still occurs in NORMAL mode (see "OMEGA Reference"), perform the Y Axis Adjustment. If the condition occurs when AXIS SWAP in the OMEGA is on, make adjustments in this order: <ol style="list-style-type: none">1. X-axis Adjustment.2. Drum End Play Adjustment.

Z Axis (Tool Height) Adjustment

Symptoms

- ◆ The tool does not touch the material or touches only between characters.
- ◆ The knife does not cut deeply enough.
- ◆ The tool height changes in the middle of a job.

Objective

To set the height of the lift fork for consistent contact of tool holder with material.

Adjustment Procedure

- 1 Turn off power at the plotter.
- 2 Adjust the pen using the pen height gage. (See *Pen Holder and Pens*).
- 3 Install the pen holder in the carriage spindle.
- 4 Turn on the plotter.
- 5 Rotate the cam shaft by hand counter-clockwise until the bottom of the lift fork touches the top of the carriage spindle. See below.
- 6 Locate the adjustment pad. There should be a gap of .003" to .010" (about the thickness of a piece of paper) between the pad and the cam shaft. If not, go to step 12.

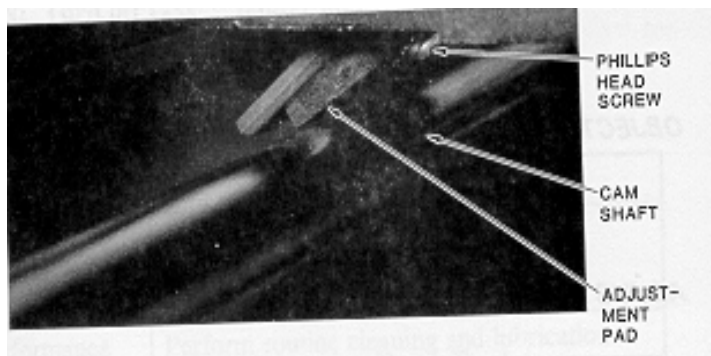

- 7 If the gap is correct, remove the rear cover (with molded tool rack). Lay the plotter on its *left* side. Remove (2) Phillips head screws from the bottom edge. Stand the plotter upright. Lift the rear cover straight up.



CAUTION: Do not rest the plotter on its right side. Do not use the way shaft to lift or turn the plotter.

- 8** Locate the Z motor collar clamp between the sensor disk and the drive motor at the end of the cam shaft. Use the Allen wrench to ensure that the set screw in the collar clamp is tightened securely.

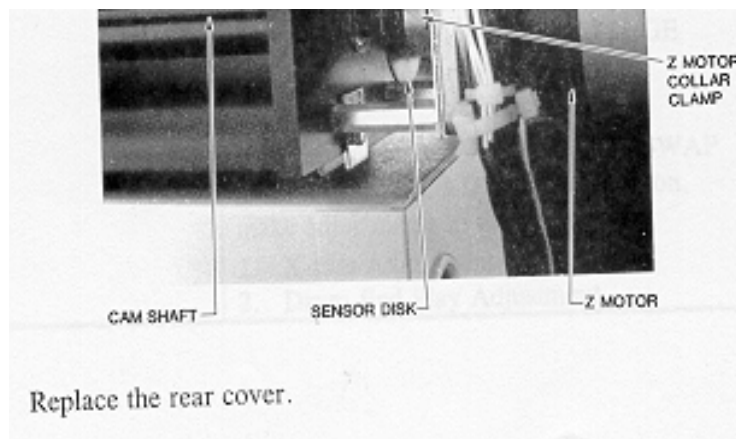

- 9** Replace the rear cover.
- 10** Load paper in the plotter. Run a multiple line test plot.
- 11** If symptoms persist, turn the plotter power off.
- 12** Rotate the cam shaft by hand until the lift fork is at its lowest position. Continue to rotate the cam shaft in the same direction. Do this until the lift fork starts to lift upward from the spindle. Then rotate the cam shaft back until it is approximately halfway between the highest and lowest positions.
- 13** At its lowest position, the lift fork should touch the top of the spindle. If the lift fork appears to be adjusted correctly, go to step 17.
- 14** If the lift fork does not touch the top of the spindle, or if it does not lift up when the cam shaft is rotated to either side, locate the screw in the center of the adjustment pad.

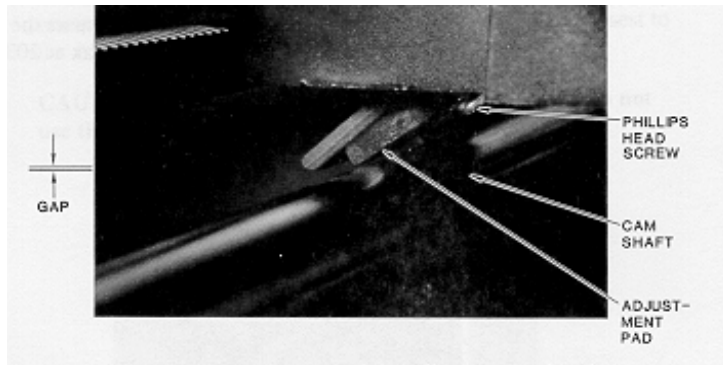

- 15** Loosen the screw in the center of the adjustment pad with a Phillips head screwdriver.



Note: If the lift fork does not touch the top of the spindle, slide the adjustment pad upward. If the lift fork remains touching the spindle when you rotate the cam shaft in either direction from its lowest position, slide the adjustment pad downward.

- 16** Retighten the adjustment pad screw.
- 17** Turn off power at the plotter.
- 18** Power up the plotter while holding the RESET key. Load paper and install pen holder.
- 19** Press the left arrow key to access the Wagon Wheel Test Plot. Press either RUN key to plot. Inspect your test plot by comparing to the **Wagon Wheel Test Plot** illustration.
- 20** Turn off power at the plotter.
- 21** Power up the plotter while holding the RESET key. Load vinyl and install knife holder.
- 22** Press the SLOW key to access the Square/Circle Test Plot. Press either RUN key to plot. Inspect your test plot by comparing to the **Square/Circle Test Plot** illustration.
- 23** If symptoms persist, return to step 1 or contact the Gerber Field Service Department at 800-828-5406, or fax at 860-871-3862.

X Axis Belt Adjustment

Symptoms

Text cut in AXIS SWAP mode has closure problems

Objective

To adjust the tension of the X motor belt to produce good letter quality in AXIS SWAP mode.

Adjustment Procedure

- 1 Turn the plotter power off.
- 2 Remove all tools and material from the plotter.
- 3 Open the bail arms.
- 4 To remove the front cover, lay the GSx^{plus} on its *left side* and remove the (2) Phillips head screws on the bottom edge closest to the front of the plotter. Then stand the plotter upright.



CAUTION: Do not rest the plotter on its right side. Do not use the way shaft to lift or turn the plotter.

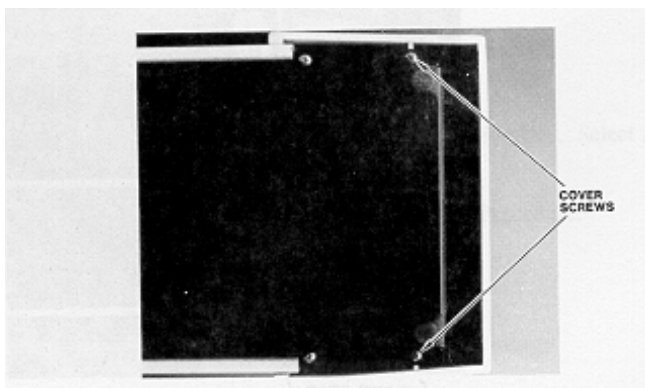

- 5 Pull the front cover upwards and, at the same time, pull one side away from the plotter frame. *Be careful not to lift the cover so high that the front cable disconnects.* Pivot the front cover to the side of the plotter.

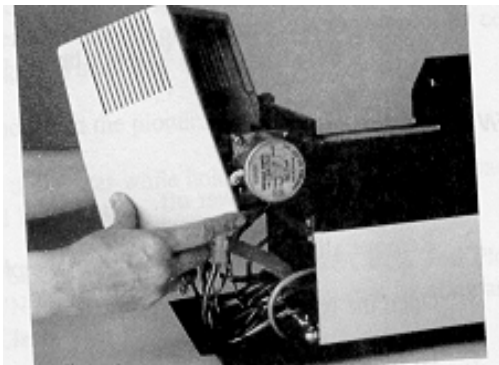

- 6** Locate the X belt. Press gently on the belt. There should be little or no spring. If the belt is loose or springy, go to Step 7.

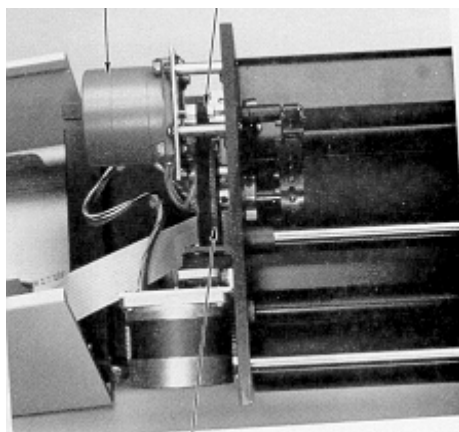

- 7** If the X motor belt requires adjustment, locate the four X motor mounting screws (Phillips head screws). Loosen these screws, which hold the X motor bracket against the standoffs on the side plate.
- 8** Pull the motor up until the belt becomes tight.

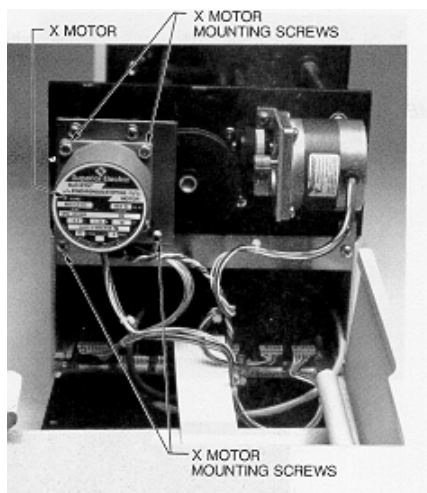

- 9** Tighten the four screws.
- 10** Turn on power at the plotter.
- 11** Load vinyl in the plotter and install the knife holder. Select AXIS SWAP mode and cut a test plot.
- 12** If symptoms persist, repeat the Adjustment Procedure.
- 13** Replace the front cover.

Y Axis Backlash Adjustment

Symptoms

Text cut in NORMAL mode has closure problems.

Objective

To adjust the mesh of the jack shaft gear with the Y motor pinion to produce good letter quality in NORMAL mode.

Adjustment Procedure

- 1 Turn the plotter power off.
- 2 Remove all tools and material from the plotter.
- 3 To remove the front cover, lay the GSx^{plus} on its side and remove the (2) Phillips head screws on the bottom edge closest to the front of the plotter. Then stand the plotter upright.

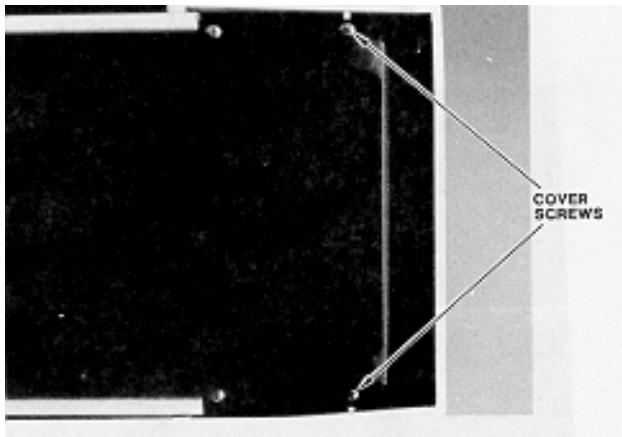

- 4 Pull the front cover upwards and, at the same time, pull one side away from the plotter frame. Be careful not to lift the cover so high that the front panel cable disconnects. Pivot the cover to the side of the plotter.

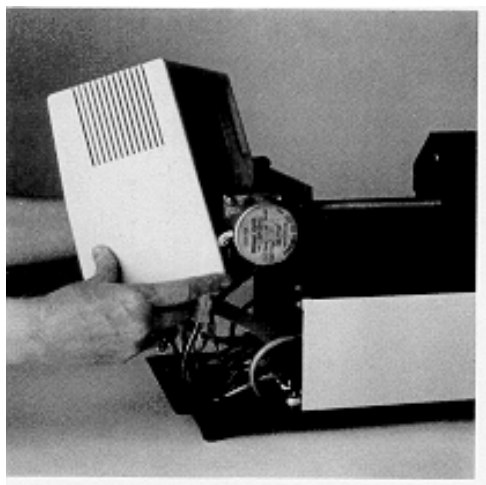

- 5 Locate the jack shaft gear and the Y motor pinion. These two gears are meshed together. Gently attempt to rotate the jack shaft gear. With one finger on the motor pinion, notice if the jack shaft gear moves while the pinion remains stationary. If the pinion moves with the jack shaft gear so there is no backlash, go to the section for Drum End Play Adjustment.

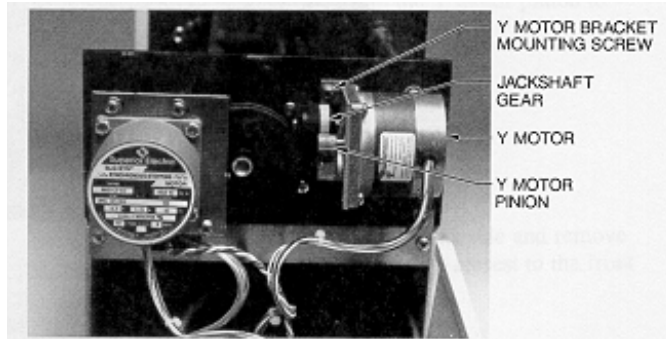

- 6 If the Y motor pinion remains stationary so there is backlash, locate the two Phillips head screws. (Only one screw is visible.) Loosen these screws which hold the Y motor bracket against the side plate.
- 7 Apply light pressure upward to tighten the mesh of the jack shaft gear and the Y motor pinion.



CAUTION: Forcing the jack shaft gear and Y motor pinion to mesh too tightly can cause the jack shaft gear to wear prematurely.

If you adjust the mesh too loosely, poor letter quality will result. However, it is safer to tighten the mesh gradually, cut a test plot, then tighten again than to adjust the mesh too tightly.

- 8 While holding the motor bracket in place, tighten the two bracket screws.
- 9 Turn the plotter power on.
- 10 Load vinyl in the plotter, install the knife holder and cut a test plot.
- 11 If symptoms persist, return to step 1.
- 12 Replace the front cover.

Drum End Play Adjustment

Symptoms

- ◆ Text cut in NORMAL mode has closure problems.
- ◆ Y axis backlash check procedure shows no problem.

Objective

To slide the plotter drum and X Axis gear toward each other and clamp them in position to remove end play; to make sure the drum still rotates without binding.

Adjustment Procedure

- 1 Turn the plotter power off.
- 2 Remove all tools and material from the plotter.
- 3 Open the bail arms to free drum.
- 4 There should be end play of about .003 to .005 inch. This play exists because the ball bearing has a flexible race.



If the amount of play does not exceed .005 inch and all check procedures in this section have failed to reveal the cause of the plotter's symptoms, contact Gerber Field Service Department at 800-828-5406, or fax at 860-871-3862.

- 5 If there is more than .003 to .005 inch of play, remove the front cover. Lay the GSx^{plus} on its *left side* and remove the (2) Phillips head screws on the bottom edge closest to the front of the plotter. Then stand the plotter upright.



CAUTION: Do not rest the plotter on its right side. Do not use the way shaft to lift or turn the plotter.

- 6 Pull the front cover upwards and, at the same time, pull one side away from the plotter frame. *Be careful not to lift the cover so high that the front panel cable disconnects.* Pivot the cover to the side of the plotter.

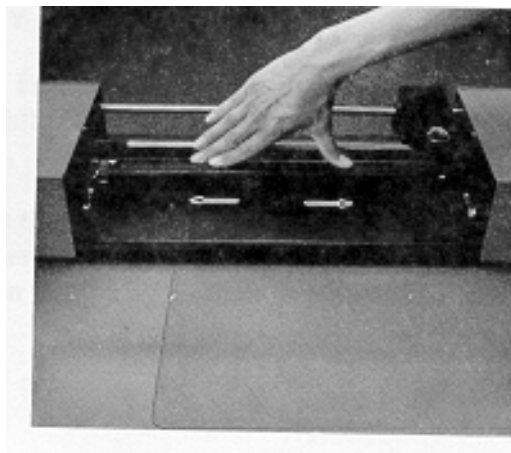

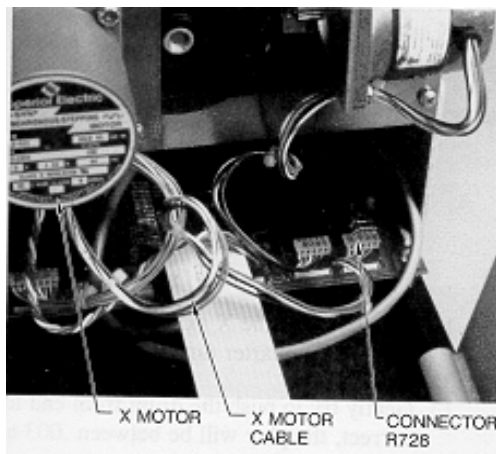

- 7** Locate connector R728 at the end of the X motor cable. Disconnect connector R728
- 8** Locate the three Phillips head screws which hold the X motor bracket against the standoffs on the side plate. Remove these screws.
- 9** Remove the X motor.
- 10** Locate the outside drum clamp on the X axis gear. Use an Allen wrench to loosen the clamp.
- 11** Locate the centerline of the frame. Slide the plotter drum and the X axis gear toward the centerline of the frame and each other. Tighten the X axis drum clamp.

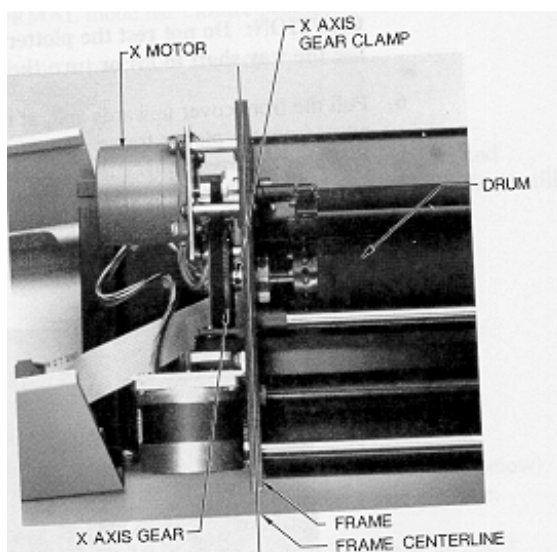

- 12** Slowly rotate the X axis gear two revolutions. Then rotate the X axis gear a quarter turn in the opposite direction.
- 13** Gently try to push the drum from end to end. If the adjustment is correct, the play will be between .003 and .005 inch.
- 14** Spin the drum. If the adjustment is correct, the drum will spin without binding.
- 15** If the tests in either step 13 or 14 fail, repeat steps 10 through 13 until the drum spins without binding *and* there is no end play.



Note: You may need to repeat this procedure several times to obtain correct adjustment.

- 16** After the adjustment is correct, reinstall the X motor. To do so, place the X motor on its standoff. Make sure the cable extends upward toward the ceiling.
- 17** Loosely install the three screws removed in step 8. Each must have a #8 lock washer and #8 flat washer. The lock washer must be closest to the screw head.
- 18** While applying pressure, tighten the three screws.
- 19** Turn on power to the plotter.
- 20** Load vinyl in the plotter, install the knife holder and cut a test plot. If closure problems persist, repeat the Adjustment Procedure from step 1.
- 21** If no closure problem appears, select AXIS SWAP mode. Cut a test plot. If closure problems persist, repeat the X Axis Backlash Adjustment Procedure.
- 22** If no closure problem appears, reinstall the front cover.

GSx^{plus} Plotter Assembly

The numbers refer to drawings on subsequent pages.

1	Spacer	45	Screw (Bracket to Standoff), Screw Washer, Nut Special Motor to Bracket
2	Motor Bracket – Y Axis	47	Cam Motor Bracket Assembly
3	Motor, Connector and Pinion Y Axis	48	Sensor Disk and Cam Assembly
4	Jackshaft Pulley and Bracket Assembly	49	Standoff
		50	Idler Pulley – Bracket Assembly
5	Bearing	51	Belt Assembly Y Axis
6	Pulley Modification	52	Rearway Grooved
7	Belt Timing X Axis	53	Spacer
8	Screw	54	Retainer
9	Motor and Pulley	55	Bearing
13	Spring (Part of Right Bail Arm Assembly P39771C)	56	Screws
		57	Roller Assembly
14	Bail Arm Screw	58	Carriage Stop Right
15	Bail Arm (Part of Bail Arm Assembly)	63	Screw
		64	Dowel
16	Paper Bail and Wheel Assembly (Part of Right and Left Bail Arm Assembly)	65	Screw
		66	Adjusting Pad
17	Screw (Part of Right Bail Arm Assembly)	67	Screw and Washer
		68	Screw
18	Bushing	69	Screw, Flat and Lock Washer
20	Plotter Base and Side Plate Assembly	71	Dowel pin (same as item 64)
23	Drum and 1 st Sprocket Assembly	72	Screw (same as item 64)
		73	Tool Lifter Pivot
24	Drum shaft (part of item 23)	74	Bearing Cap (part of item 82)
33	Screw		
34	Sprint (part of left bail arm assembly PP39772C)	75	Spindle Assembly
35	Left Bail Arm (Part of Left Bail Arm Assembly)	81	Nut
36	Shoulder Screw (Long)	82	Vertical Lift Carriage and Bearing Cap
37	Front Way	83	Tool force Housing Assembly
38	Carriage Stop Left	84	Bail Arm Screw (same as item 14)
40	Bushing	85	Wired Photo Interrupter Board

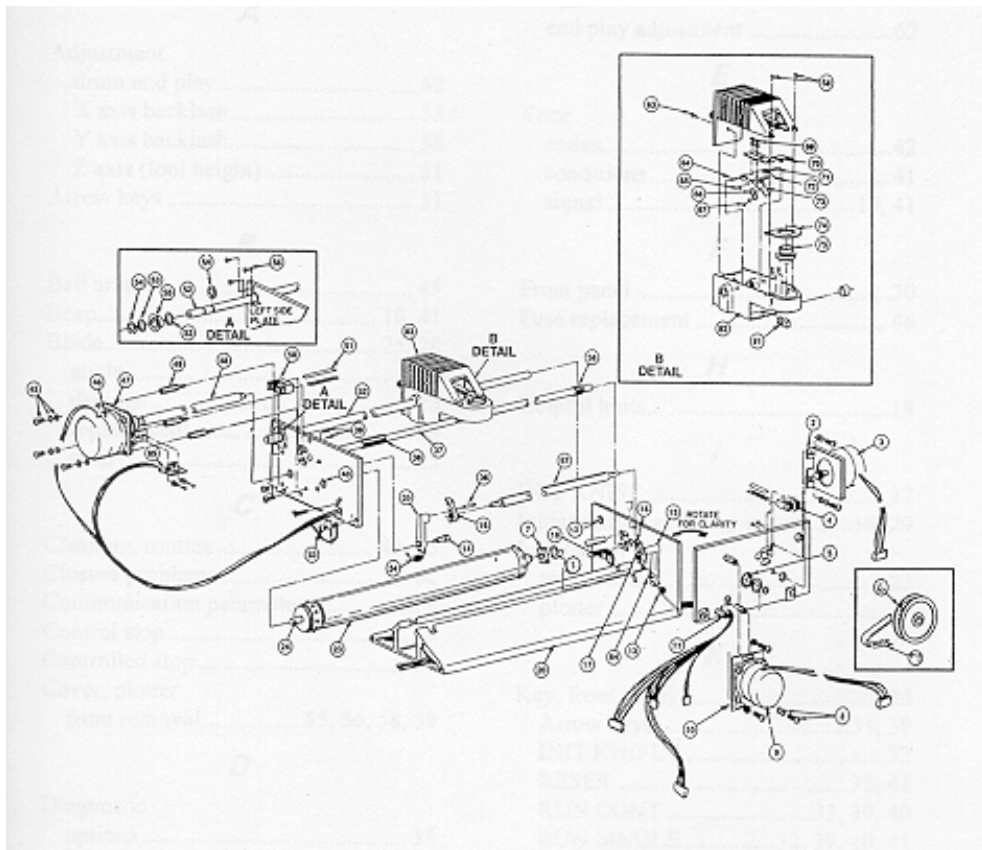
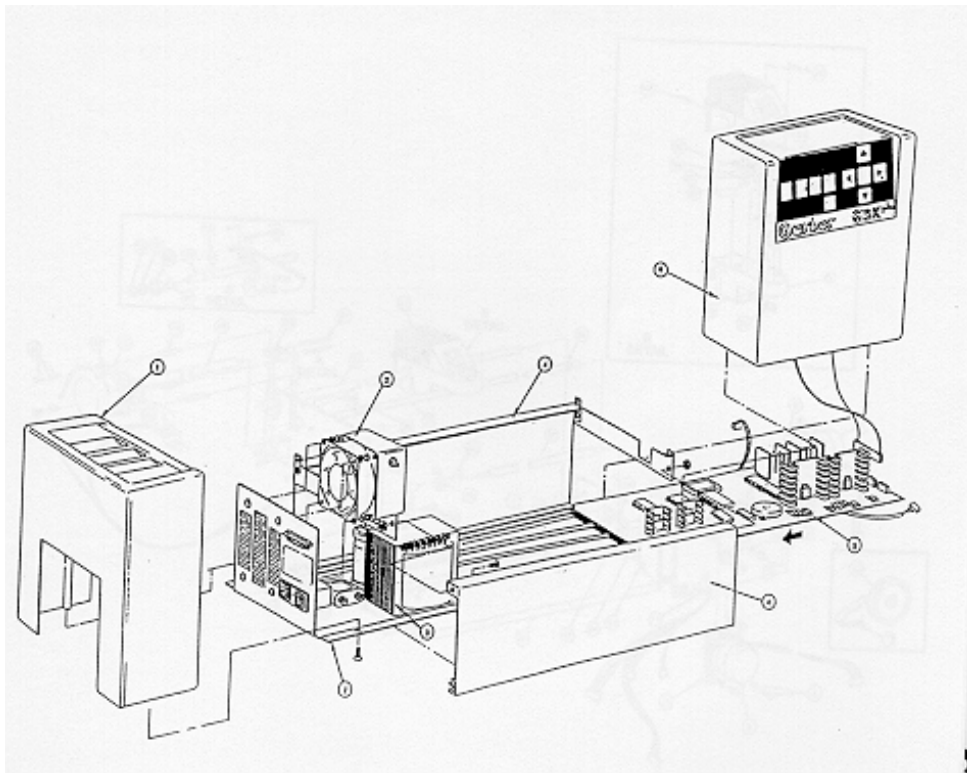

Index

A

Adjustment	
drum end play.....	50
X axis backlash.....	45
Y axis backlash.....	48
Z axis (tool height).....	42
Arrow keys.....	27

B

Bail arms.....	37
Beep.....	10, 34
Blade.....	23, 25
angle.....	19
damage.....	23
replacement.....	25
wear.....	23

C

Cleaning, routine.....	37
Closure problems.....	50
Communication parameters.....	9
Controll stop.....	29
Controlled stop.....	28
Cover, plotter	
front removal.....	45, 48
Cut test, X08.....	33

D

Diagnostic	
options.....	31
RS-232 loop-back.....	31
square/circle test plot.....	31
wagon wheel test plot.....	31
X,Y,Z axes.....	31
Diagnostics	
access.....	30
access special.....	31
special.....	31

Drum	
end play adjustment.....	50

E

Error	
codes.....	35
conditions.....	34
signal.....	34
signal.....	10

F

Front panel.....	26
Fuse replacement.....	38

H

Helpful hints.....	17
--------------------	----

I

INIT KNIFE.....	28
Initial setting at power-up.....	10, 26
Installation	
pen holder.....	21
plotter.....	8

K

Key, front panel.....	26
Arrow keys.....	27, 32
INIT KNIFE.....	28
RESET.....	30, 34
RUN CONT.....	29, 32
RUN SINGLE.....	28, 32, 34
slew keys (<i>Also see Arrow keys</i>)	27
slew keys (<i>Also see Arrowa keys</i>)	27
SLOW.....	31, 32
SLOW.....	27
Keyway.....	21
Knife holder.....	23
installation.....	23

L	
Light (s), front panel	31, 34
Lubrication, routine	37

M	
Maintenance	
carriage and ball bushing	37
carriage spindle bore	36
cleaning and lubrication	36
fuse replacement.....	38
sprockets and bail arms	37
tool holders.....	36
Materials	15

P	
Pen	
height gauge	22
replacement	22
Pen holder	21
Pen Holder	
installation	21
Plot	
continuous exercise	29
single exercise	28
Square/Circle test plot.....	33
Square/Circle Test Plot	31, 32
Wagon Wheel Test Plot.....	31, 32
Plotter	
add plotter.....	13
adjustments.....	40
assign default.....	14
delete plotter.....	13
installation	8
Power cord	9, 10
Power-Up	10, 26

R	
RESET	30
Roll holder, material	8, 15
RUN CONT	29

RUN SINGLE.....	28
-----------------	----

S	
Slew keys	27, 28
SLOW SLEW	27
Sprockets.....	16, 17, 37, 38
Square/Circle Test Plot.....	31, 32
Stop, controlled.....	28, 29
Stop, emergency.....	30
Symptoms	
plotter adjustment... ..	40, 42, 45, 48, 50

T	
Tone	10, 34
Tool force.....	18, 19
adjustments.....	19
logbook.....	19
setting	18, 24
Tool holders	20
Tool rack, molded	21
Tool storage	20
Trouble shooting guide	40

V	
Vinyl	15, 37

W	
Wagon Wheel Test Plot	31, 32

X	
X Axis	
backlash adjustment	45
X, Y, Theta axes	
lock timeout.....	35
X, Y, Z axes	
lock timeout.....	35

Y	
Y axis	
backlash adjustment	48

Z

Z axis	
tool height adjustment	42

GSx^{plus} plotter user reference card

Key/Function	Description
RUN SINGLE key	
Plot	Press RUN SINGLE to plot single jobs. The GSx ^{plus} returns to the off-line status (as at power-up) after each job and waits for the operator to press RUN SINGLE key again to plot the next job.
Controlled Stop	Press either RUN key to stop plotting at the next logical break in the program and check current job. <i>Do not use slew keys or the orientation for the current job will be lost.</i>
RUN CONT key	
Plot	Press RUN CONT to plot two or more jobs continuously. The GSx ^{plus} plots one job after the other without pausing between them and remains on-line until either RUN key is pressed.
Controlled Stop	Press either RUN key to stop plotting at the next logical break in the program and check current job. <i>Do not use slew keys or the orientation for current job will be lost.</i>
Slew Keys (Arrow Keys)	The arrow and SLOW keys do not function while a job is plotting, during an error condition, or while a RUN light is on, even if the plotter is idle.
	Press arrow keys to position carriage and material between jobs: <ul style="list-style-type: none"> • Up and down arrow keys move the carriage spindle between the rear and the front of the plotter. • Left and right arrow keys rotate the drum and feed material through the plotter or back toward the roll holder.
Slow Key	Hold the SLOW key while simultaneously pressing any Arrow key. This slows carriage movement for exact positioning.
Reset Key	
Emergency Stop	Press the RESET key to stop GSx ^{plus} operation, clear the current job from the buffer, and return the plotter to off-line status.
Clear	Press the RESET key to stop the error signal after a power-up or plotting failure. (See Error Conditions Section).
Access	Hold the RESET key at power-up to access additional diagnostics. (See Special Diagnostics Section)

